

SB600 | 18.1L | 600 kW

INDUSTRIAL BI-FUEL GENERATOR SET

EPA Compliant Stationary Emergency

GENERAC® | **INDUSTRIAL POWER**

Standby Power Rating

600 kW, 750 kVA, 60 Hz

Prime Power Rating*

540 kW, 675 kVA, 60 Hz

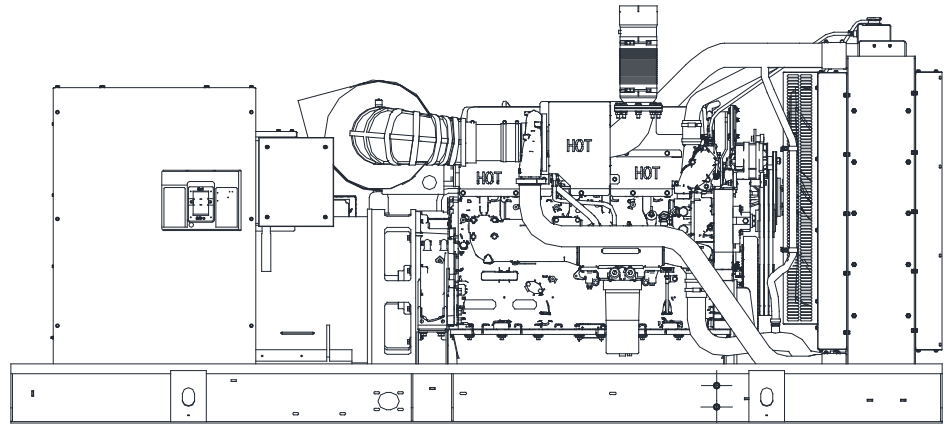



Image used for illustration purposes only





*EPA Compliant Prime ratings are not available in the US or its Territories

Codes and Standards

Not all codes and standards apply to all configurations. Contact factory for details.

 UL2200, UL6200, UL 1236, UL489, UL142

 CSA C22.2, ULC S601, B149

 BS5514 and DIN 6271

 SAE J1349

 NFPA 37, 70, 99, 110

 NEC700, 701, 702, 708

 ISO 3046, 7637, 8528, 9001

 NEMA ICS10, MG1, 250, ICS6, AB1

 ANSI C62.41

 IBC 2009, CBC 2010, IBC 2012, ASCE 7-05, ASCE 7-10, ICC-ES AC-156 (2012)

Powering Ahead

Generac Bi-Fuel™ generators start on diesel fuel and add natural gas as load is applied until the unit runs primarily on natural gas. Generac's Bi-Fuel generators are fully integrated solutions, not aftermarket conversions in the field. That means every component is specifically designed, engineered and factory-validated to work together. Generac Bi-Fuel generators have the added benefit of being EPA-compliant from the factory.

RISK MITIGATION VIA FUEL REDUNDANCY

Because nobody can predict how long a power outage will last, many diesel-fueled standby power systems are sized for extended running times. Nevertheless, onsite diesel fuel supplies are limited, and infrastructure damage could make refueling difficult. Generac Bi-Fuel generators make the most of an onsite diesel fuel supply by running primarily on natural gas. That means less onsite diesel fuel is required and running times will be greatly extended compared to diesel-only solutions. And because the natural gas infrastructure tends not to be affected by the same conditions that lead to power outages, fuel reliability is improved.

LOWER TOTAL COST OF OWNERSHIP

Because natural gas costs less than diesel, fuel costs are significantly reduced over the long term. And since less onsite diesel fuel is required for long running times, installation, operational and maintenance costs are reduced.

SCALABILITY AS PART OF A MODULAR POWER SYSTEM

Generac Bi-Fuel generators can be configured as part of a Modular Power System (MPS)—connected via integrated paralleling with other Generac generators. This makes the system scalable, meaning there is no need to install more power than you need.

CODE COMPLIANCE

Generac Bi-Fuel generators meet the onsite fuel requirements for emergency systems as referenced in NEC700 and NFPA 110. Less onsite diesel fuel means easier permitting. And indoor fuel installations with capacity limits per NFPA or local codes become a viable option.

SB600 | 18.1L | 600 kW INDUSTRIAL BI-FUEL GENERATOR SET

EPA Compliant Stationary Emergency

STANDARD FEATURES

ENGINE SYSTEM

- Oil Drain Extension
- Air Cleaner
- Level 1 Fan and Belt Guards (Open Set Only)
- Stainless Steel Flexible Exhaust Connection
- Critical Silencer (Enclosed Units Only)
- Factory Filled Oil and Coolant

Fuel System

- Primary and Secondary Fuel Shutoff
- Primary and Secondary Fuel Filters

Cooling System

- Closed Coolant Recovery System
- UV/Ozone Resistant Hoses
- Factory-Installed Radiator
- 50/50 Ethylene Glycol Antifreeze

Electrical System

- Battery Charging Alternator
- Battery Cables
- Battery Tray
- Rubber-Booted Engine Electrical Connections
- Solenoid Activated Starter Motor

ALTERNATOR SYSTEM

- Class H Insulation Material
- 2/3 Pitch
- Skewed Stator
- Permanent Magnet Excitation
- Amortisseur Winding
- Sealed Bearing
- Full Load Capacity Alternator

GENERATOR SET

- Internal Genset Vibration Isolation
- Separation of Circuits - High/Low Voltage
- Separation of Circuits - Multiple Breakers
- Wrapped Exhaust Piping (Enclosed Units Only)
- Standard Factory Testing
- 2 Year Limited Warranty (Standby Rated Units)
- 1 Year Limited Warranty (Prime Rated Units)
- Silencer Mounted on the Discharge Hood (Enclosed Units Only)

ENCLOSURE (If Selected)

- Rust-Proof Fasteners with Nylon Washers to Protect Finish
- High Performance Sound-Absorbing Material (Sound Attenuated Enclosure)
- Gasketed Doors
- Upward Facing Discharge Hoods (Radiator and Exhaust)
- Stainless Steel Lift Off Door Hinges
- Stainless Steel Lockable Handles
- RhinoCoat™ - Textured Polyester Powder Coat Paint

TANK (If Selected)

- UL 142/ULC S601
- Double Wall
- Vents
- Sloped Top
- Sloped Bottom
- Factory Pressure Tested (2 psi)
- Rupture Basin Alarm
- Fuel Level
- Check Valve in Supply and Return Lines
- RhinoCoat™ - Textured Polyester Powder Coat Paint
- Stainless Hardware

CONTROL SYSTEM



Digital G Paralleling Control Panel-Touchscreen

Program Functions

- Programmable Crank Limiter
- 7-Day Programmable Exerciser
- Special Applications Programmable Logic Controller
- RS-232/485 Communications
- All Phase Sensing Digital Voltage Regulator

PARALLELING CONTROLS

- Auto-Synchronization Process
- Isochronous Load Sharing
- Reverse Power Protection

- 2-Wire Start Capability
- Date/Time Fault History (Event Log)
- Isochronous Governor Control
- Waterproof/Sealed Connectors
- Audible Alarms and Shutdowns
- Not in Auto (Flashing Light)
- Auto/Off/Manual Switch
- E-Stop (Red Mushroom-Type)
- NFPA 110 Level I and II (Programmable)
- Customizable Alarms, Warnings, and Events
- Modbus® Protocol
- Predictive Maintenance Algorithm
- Sealed Boards
- Password Parameter Adjustment Protection
- Single Point Ground
- 16 Channel Remote Trending
- 0.2 Msec High Speed Remote Trending
- Alarm Information Automatically Annunciated on the Display

Full System Status Display

- Power Output (kW)
- Power Factor
- kW Hours, Total, and Last Run

- Real/Reactive/Apparent Power
- All Phase AC Voltage
- All Phase Currents
- Oil Pressure
- Coolant Temperature
- Coolant Level
- Engine Speed
- Battery Voltage
- Frequency

Alarms and Warnings

- Oil Pressure
- Coolant Temperature
- Coolant Level
- Low Fuel Pressure
- Engine Overspeed
- Battery Voltage
- Alarms and Warnings Time and Date Stamped
- Snap Shots of Key Operation Parameters During Alarms and Warnings
- Alarms and Warnings Spelled Out (No Alarm Codes)

- Optional Programmable Logic Full Auto Back-Up Controls (PLS)
- Shunt Trip and Auxiliary Contact

CONFIGURABLE OPTIONS

ENGINE SYSTEM

- Level 1 Fan and Belt Guards (Enclosed Units Only)
- Oil Heater
- Engine Coolant Heater
- Shipped Loose Critical Silencer (Open Set Only)
- Radiator Stone Guard (Open Set Only)

FUEL SYSTEM

- NPT Flexible Fuel Line

ELECTRICAL SYSTEM

- 10A UL Listed Battery Charger
- Battery Warmer

ALTERNATOR SYSTEM

- Alternator Upsizing
- Anti-Condensation Heater

CIRCUIT BREAKER OPTIONS

- Main Line Circuit Breaker
- 2nd Main Line Circuit Breaker
- Shunt Trip and Auxiliary Contact
- Electronic Trip Breakers

GENERATOR SET

- Extended Factory Testing
- IBC Seismic Certification
- 12 Position Load Center

ENCLOSURE

- Weather Protected Enclosure
- Level 1 Sound Attenuated
- Level 2 Sound Attenuated
- Level 2 Sound Attenuated with Motorized Dampers
- Steel Enclosure
- Aluminum Enclosure
- Up to 200 MPH Wind Load Rating (Contact Factory for Availability)
- AC/DC Enclosure Lighting Kit
- Enclosure Heater (with Motorized Dampers Only)

CONTROL SYSTEM

- NFPA 110 Compliant 21-Light Remote Annunciator
- Remote Relay Assembly (8 or 16)
- Oil Temperature Indication and Alarm
- Remote E-Stop (Break Glass-Type, Surface Mount)
- Remote E-Stop (Red Mushroom-Type, Surface Mount)
- Remote E-Stop (Red Mushroom-Type, Flush Mount)
- Remote Communication - Modem
- 10A Engine Run Relay
- 100 dB Alarm Horn
- 120V GFCI and 240V Outlets
- Damper Alarm Contacts (with Motorized Dampers Only)
- Ground Fault Annunciator

WARRANTY (Standby Gensets Only)

- 2 Year Extended Limited Warranty
- 5 Year Limited Warranty
- 5 Year Extended Limited Warranty
- 7 Year Extended Limited Warranty
- 10 Year Extended Limited Warranty

ENGINEERED OPTIONS

ENGINE SYSTEM

- Fluid Containment Pan

ALTERNATOR SYSTEM

- 3rd Breaker Systems

CONTROL SYSTEM

- Battery Disconnect Switch

GENERATOR SET

- Special Testing

FUEL TANKS

- Overfill Protection Valve
- UL 2085 Tank
- Stainless Steel Tank
- Special Fuel Tanks (MIDEQ and FL DEP/DERM, etc)
- Vent Extensions

APPLICATION AND ENGINEERING DATA

ENGINE SPECIFICATIONS

General

Make	Perkins
EPA Emissions Compliance	Stationary Emergency
EPA Emissions Reference	See Emission Data Sheet
Cylinder #	6
Type	In-Line
Displacement - in ³ (L)	1,106.36 (18.13)
Bore - in (mm)	5.71 (145)
Stroke - in (mm)	7.20 (183)
Compression Ratio	14.5:1
Intake Air Method	Turbocharged/Aftercooled
Cylinder Head Type	4-Valve
Piston Type	Aluminum
Crankshaft Type	I-Beam Section

Engine Governing

Governor	Electronic Isochronous
Frequency Regulation (Steady State)	±0.25%

Lubrication System

Oil Pump Type	Gear
Oil Filter Type	Full Flow
Crankcase Capacity - qt (L)	47.55 (45)

Cooling System

Cooling System Type	Closed Recovery
Water Pump Type	Centrifugal Type, Belt-Driven
Fan Type	Pusher
Fan Speed - RPM	1,439
Fan Diameter - in (mm)	38 (965)

Fuel System

Fuel Type	Ultra Low Sulfur Diesel #2
Carburetor	ASTM
Fuel Filtering (Microns)	Primary 10 - Secondary 2
Fuel Inject Pump	Electronic
Injector Type	MEUI
Engine Type	Pre-Combustion
Fuel Supply Line - in (mm)	0.5 (12.7) NPT
Fuel Return Line - in (mm)	0.5 (12.7) NPT
Required Natural Gas Pressure - psi (kPa)	1 (7)
Maximum Required Volume of Natural Gas Needed - scfm (m ³ /min)	50 (15)

Engine Electrical System

System Voltage	24 VDC
Battery Charger Alternator	70 Amps
Battery Size	See Battery Index 0161970SBY
Battery Voltage	(2) - 12 VDC
Ground Polarity	Negative

ALTERNATOR SPECIFICATIONS

Standard Model	K0792124Y23
Poles	4
Field Type	Revolving
Insulation Class - Rotor	H
Insulation Class - Stator	H
Total Harmonic Distortion	<3%
Telephone Interference Factor (TIF)	<50

Standard Excitation	Permanent Magnet
Bearings	Single Sealed Cartridge
Coupling	Direct via Flexible Disc
Prototype Short Circuit Test	Yes
Voltage Regulator Type	Full Digital
Number Of Sensed Phases	All
Regulation Accuracy (Steady State)	±0.25%

OPERATING DATA

POWER RATINGS

		Standby
Three-Phase 120/208 VAC @0.8pf	600 kW	Amps: 2,081
Three-Phase 120/240 VAC @0.8pf	600 kW	Amps: 1,804
Three-Phase 277/480 VAC @0.8pf	600 kW	Amps: 903
Three-Phase 346/600 VAC @0.8pf	600 kW	Amps: 723

MOTOR STARTING CAPABILITIES (skVA)

skVA vs. Voltage Dip			
277/480 VAC	30%	208/240 VAC	30%
K0792124Y23	2,250	K0792124Y23	2,000
K0832124Y23	2,800	K0832124Y23	2,090

FUEL CONSUMPTION RATES*

Fuel Pump Lift - ft (m)	Diesel Only – gph (Lph)**	
	Percent Load	Standby
12 (3.7)	25%	18.4 (69.7)
	50%	28.2 (88.7)
Total Fuel Pump Flow (Combustion + Return) gph (Lph)	75%	35.6 (124.8)
121 (457)	100%	41.4 (156.7)

* Fuel supply installation must accommodate fuel consumption rates at 100% load.
 ** Natural Gas substitution may vary based on the application and load conditions
 Please contact factory for additional details on fuel consumption

COOLING

		Standby
Coolant Flow	gpm (Lpm)	114.1 (432)
Coolant System Capacity	gal (L)	15.5 (58.6)
Heat Rejection to Coolant	BTU/hr (kW)	1,589,760 (466)
Inlet Air	cfm (m ³ /min)	30,088 (852)
Maximum Operating Ambient Temperature	°F (°C)	122 (50)
Maximum Operating Ambient Temperature (Before Derate)	See Bulletin No. 0199270SSD	
Maximum Additional Radiator Backpressure	in H ₂ O (kPa)	0.5 (0.12)

COMBUSTION AIR REQUIREMENTS

	Standby
Flow at Rated Power - cfm (m ³ /min)	1,836 (52)

ENGINE

		Standby
Rated Engine Speed	RPM	1,800
Horsepower at Rated kW**	hp	909
Piston Speed	ft/min (m/min)	2,161 (659)
BMEP	psi (kPa)	361 (2,489)

EXHAUST

		Standby
Exhaust Flow (Rated Output)	cfm (m ³ /min)	5,085 (144)
Maximum Allowable Backpressure (Post Turbo)	inHg (kPa)	2.13 (6.9)
Exhaust Temperature (Rated Output - Post Silencer)	°F (°C)	1,155 (624)

** Refer to "Emissions Data Sheet" for maximum bHP for EPA and SCAQMD permitting purposes.

Deration – Operational characteristics consider maximum ambient conditions. Derate factors may apply under atypical site conditions.

Please contact a Generac Power Systems Industrial Dealer for additional details. All performance ratings in accordance with ISO3046, BS5514, ISO8528, and DIN6271 standards.

Standby - See Bulletin 0187500SSB

Prime - See Bulletin 0187510SSB

DIMENSIONS AND WEIGHTS*

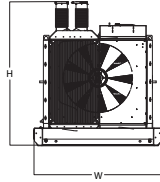
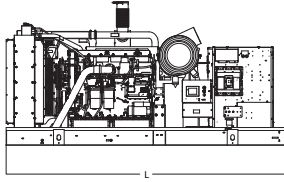

OPEN SET

Run Time - Hours	Usable Capacity - Gal (L)	L x W x H - in (mm)	Weight - lbs (kg)	
			Steel	Aluminum
No Tank	-	154.4 (3,923) x 71.0 (1,803) x 67.3 (1,709)	8,662 - 10,922 (3,929 - 4,954)	
8	334	158.5 (4,025) x 71.0 (1,803) x 81.3 (2,065)	10,337 - 12,667 (4,680 - 5,705)	
24	1,001	158.5 (4,025) x 71.0 (1,803) x 103.3 (2,623)	11,262 - 13,522 (5,108 - 6,133)	
24	1,001	228.0 (5,791) x 71.0 (1,803) x 92.3 (2,344)	11,812 - 14,072 (5,358 - 6,383)	
48	2,002	290.0 (7,366) x 71.0 (1,803) x 103.3 (2,623)	13,512 - 15,722 (6,129 - 7,154)	

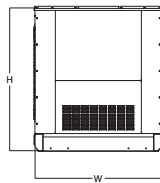
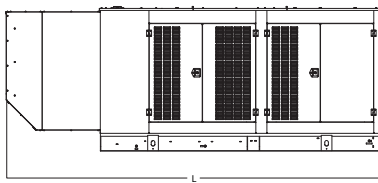

WEATHER PROTECTED ENCLOSURE

Run Time - Hours	Usable Capacity - Gal (L)	L x W x H - in (mm)	Weight - lbs (kg) Enclosure Only	
			Steel	Aluminum
No Tank	-	207.4 (5,268) x 70.9 (1,800) x 79.9 (2,031)		
8	334	207.4 (5,268) x 70.9 (1,800) x 93.9 (2,387)		
24	1,001	207.4 (5,268) x 70.9 (1,800) x 115.9 (2,945)	2,468 (1,119)	1,378 (625)
24	1,001	228.0 (5,791) x 70.9 (1,800) x 104.9 (2,666)		
48	2,002	290.0 (7,366) x 70.9 (1,800) x 115.9 (2,945)		

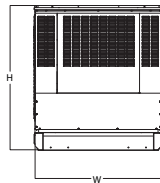
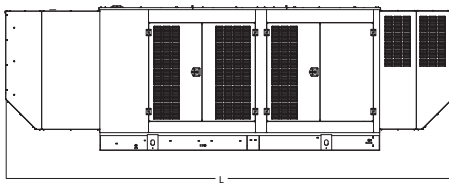

LEVEL 1 SOUND ATTENUATED ENCLOSURE

Run Time - Hours	Usable Capacity - Gal (L)	L x W x H - in (mm)	Weight - lbs (kg) Enclosure Only	
			Steel	Aluminum
No Tank	-	247.5 (6,285) x 70.9 (1,800) x 80.0 (2,032)		
8	334	247.5 (6,285) x 70.9 (1,800) x 94.0 (2,388)		
24	1,001	247.5 (6,285) x 70.9 (1,800) x 116.0 (2,946)	3,472 (1,574)	1,812 (821)
24	1,001	247.5 (6,285) x 70.9 (1,800) x 105.0 (2,667)		
48	2,002	290.0 (7,366) x 70.9 (1,800) x 116.0 (2,946)		

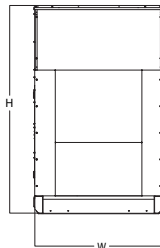
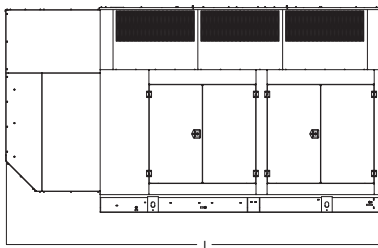

LEVEL 2 SOUND ATTENUATED ENCLOSURE

Run Time - Hours	Usable Capacity - Gal (L)	L x W x H - in (mm)	Weight - lbs (kg) Enclosure Only	
			Steel	Aluminum
No Tank	-	207.4 (5,268) x 70.9 (1,800) x 114.1 (2,899)		
8	334	207.4 (5,268) x 70.9 (1,800) x 128.1 (3,255)		
24	1,001	207.4 (5,268) x 70.9 (1,800) x 150.1 (3,813)	3,810 (1,728)	1,956 (887)
24	1,001	228.0 (5,791) x 70.9 (1,800) x 139.1 (3,534)		
48	2,002	290.0 (7,366) x 70.9 (1,800) x 150.1 (3,813)		

* All measurements are approximate and for estimation purposes only.

YOUR FACTORY RECOGNIZED GENERAC INDUSTRIAL DEALER

Specification characteristics may change without notice. Dimensions and weights are for preliminary purposes only. Please contact a Generac Power Systems Industrial Dealer for detailed installation drawings.